



KITCHEN APPLIANCES

GUANGDONG GOLENDIA INTELLIGENT MANUFACTURING TECHNOLOGY CO LTD is holding by the Listed company Shenzhen CHK Co., Ltd. We are a national high-tech enterprise and specialized small giant enterprise engaged in the research and development of intelligent control technology and product innovation for household appliances. Our company's shares had been listed on Beijing Stock Exchange on May 27, 2022, with stock code 831167.

The main business of Our company is the intelligent control technology and its product application in the field of household appliances, and the distribution of semiconductor components. Its main customers include well-known household appliance brands at home and abroad, such as Midea, Supor, Philips, Boss Appliances, etc. We had strong technological innovation capabilities, especially in the field of electromagnetic induction heating technology. The IH solution chip developed by us has been recognized as a "Shenzhen independent innovation product". As the leader unit, Our company has organized the development of the "Integrated Electromagnetic Heating Controller" national industry standard. Our company has explored and practiced the development path of "extending to the downstream of the industrial chain based on the chip products carrying the company's intelligent control scheme", has the ability to complete the industrial chain of household appliance, and meets the one-stop purchase needs of customers from the scheme chips to intelligent controllers and household appliance.

"Improving people's quality of life with high-quality user experience and excellent product quality, Continuously contribute to the harmonious development of nature and society " is our Company Mission





# OVEN

**4D convection**

**Dual cooling air flue**

**Pop out knobs**

**Soft close door hinge**

**Rotisserie**

**Telescopic runners & rack support**

**Removed door with 2-4 layer glasses**

**Easy clean inner glass**

**Deep tray / universal tray**

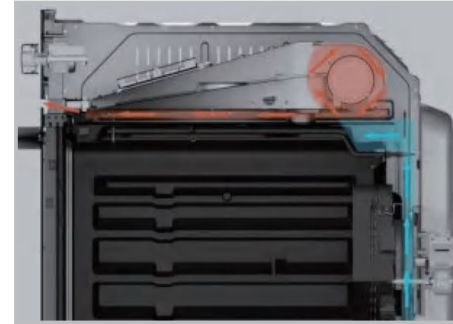

# OVEN Special Features

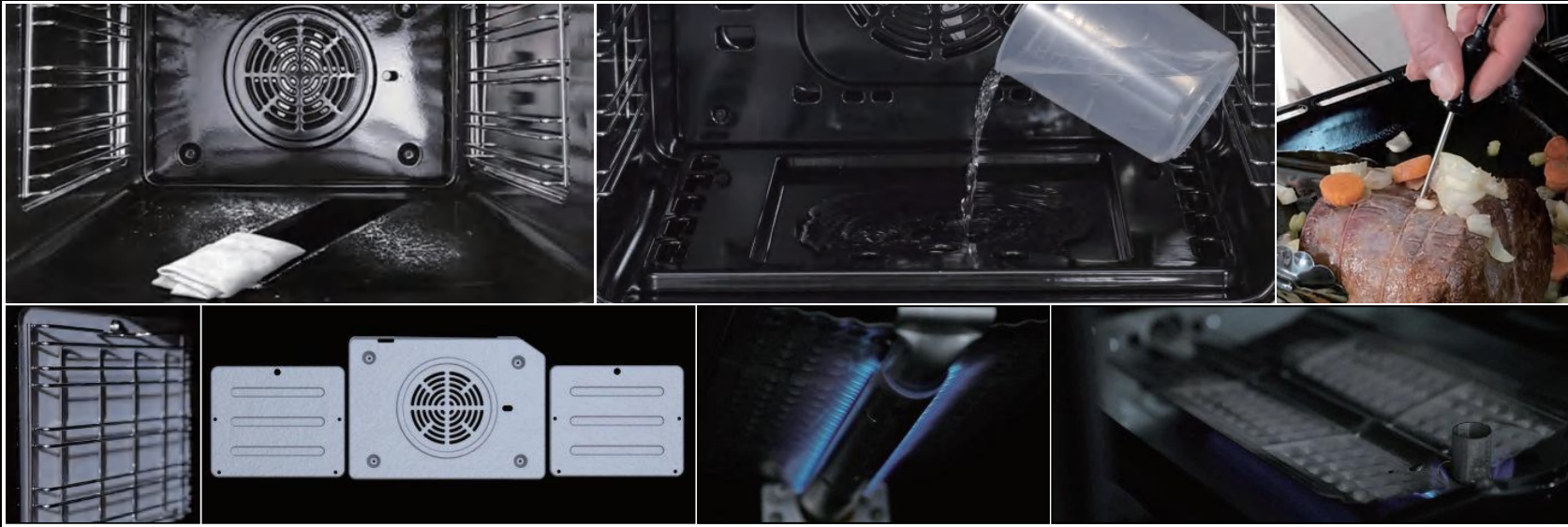

Pyrolytic Self-cleaning

Catalytic Cleaning

Steam Cleaning

Top gas burner

Temperature Probe

Bottom gas burner

# SINGLE WALL ELECTRIC OVEN & GAS OVEN

## 68L/70L/73L

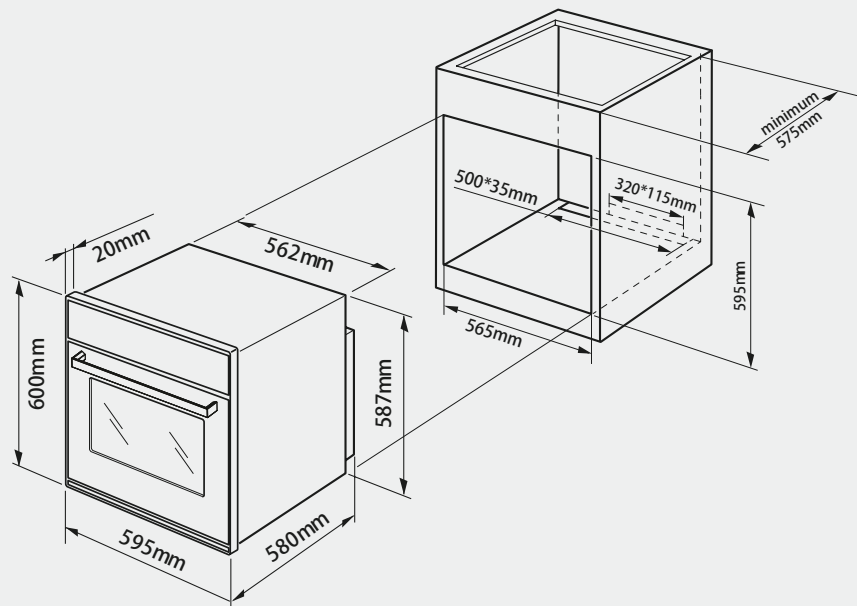

Net (WxDxH): 595x580x600mm  
 Net (WxDxH): 595x498x600mm

Packaging (WxDxH): 625x675x650mm  
 Packaging (WxDxH): 625x572x643mm

## 64L

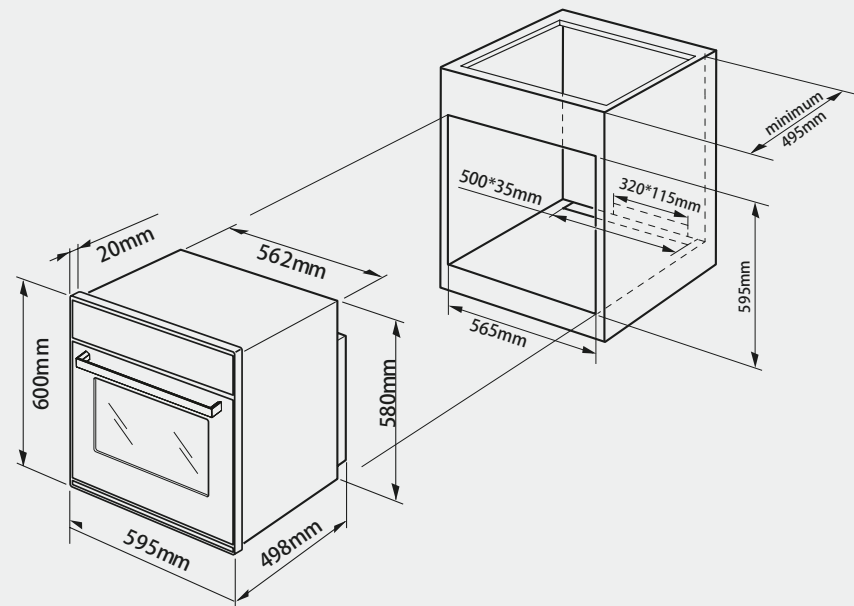

Cut-out: 565x575x595mm  
 Cut-out: 565x495x595mm

20GP: 81      40GP: 162      40HQ: 225      68L / 70L / 73L  
 20GP: 108      40GP: 224      40HQ: 300      64L

## Low-E-inner glass

offers you a good temperature performance and prevent glass from bursting.

eucalyptus populus

-  Oven lamp
-  Defrost
-  Bottom heater on / Steam clean
-  Top heater on
-  Bottom and top heaters on
-  Rear and bottom heating with grilling and fan
-  Rear and bottom heating and fan
-  Combined grill on
-  Grill element on
-  Fan and combined grill on
-  Fan and grill
-  Rear element with fan
-  Rotisserie with grill and fan
-  Fan and bottom and top heaters on
-  Pyrolytic Self-cleaning
-  ECO
-  Bottom gas burner
-  Top gas burner
-  Temperature probe

# DIGITAL INTELLIGENT ELECTRONIC OVEN

MAX. POWER: 2900W / 73L      2600W / 64L

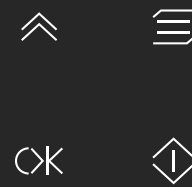
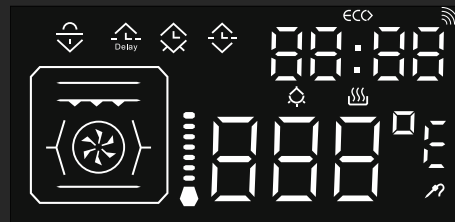
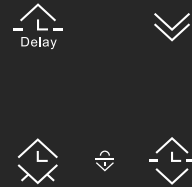
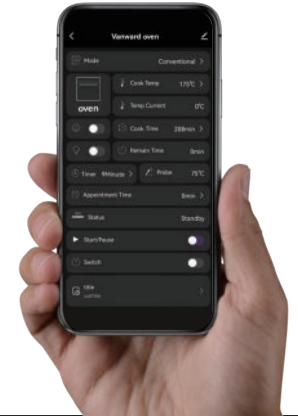

# DIGITAL INTELLIGENT ELECTRONIC OVEN

MAX. POWER: 2900W / 73L      2600W / 64L

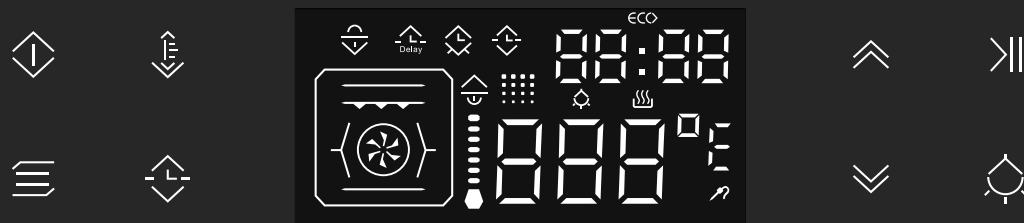

# DIGITAL INTELLIGENT ELECTRONIC OVEN

MAX. POWER: 2900W / 73L      2600W / 64L

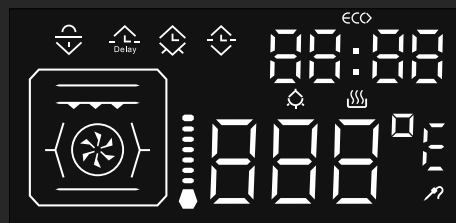

## RECOMMEND APPEARANCE



①



②



③



④



⑤

# DIGITAL INTELLIGENT ELECTRONIC OVEN

MAX. POWER: 2900W / 73L      2600W / 64L



## RECOMMEND APPEARANCE



# DIGITAL INTELLIGENT ELECTRONIC OVEN

MAX. POWER: 2900W / 73L      2600W / 64L

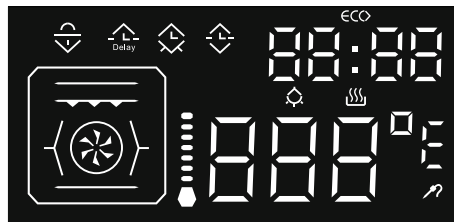

## RECOMMEND APPEARANCE



①



②



③

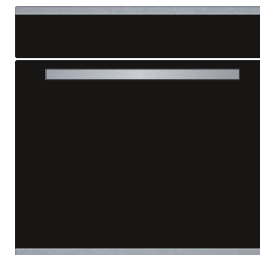

④



⑤

# DIGITAL INTELLIGENT ELECTRONIC OVEN

MAX. POWER: 2900W / 73L      2600W / 64L

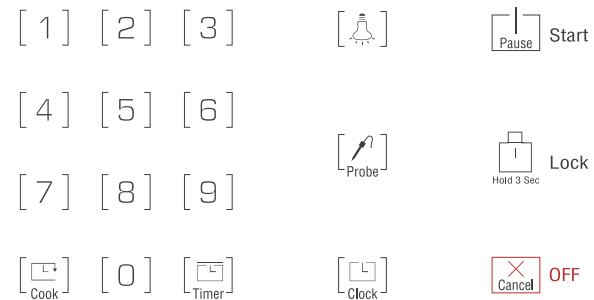
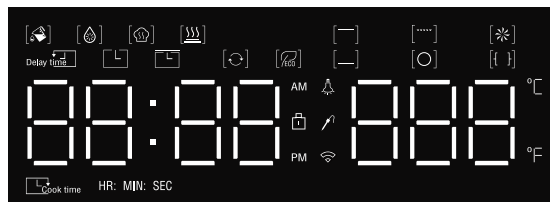
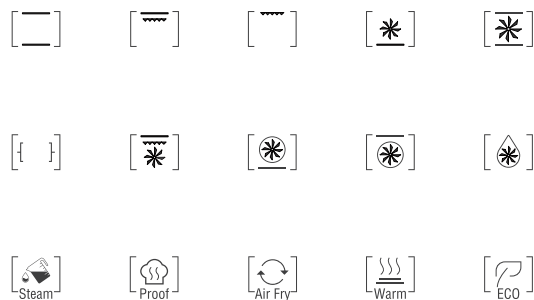

## RECOMMEND APPEARANCE



①



②

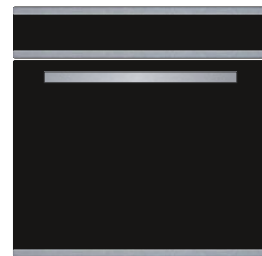

③

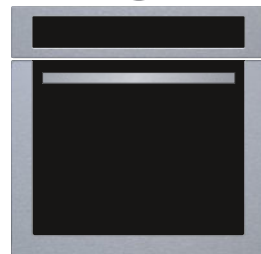

④



⑤



## RECOMMEND APPEARANCE



①



②



③



④

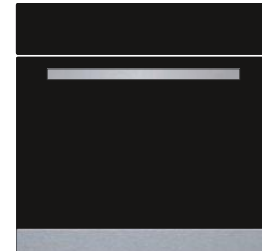

⑤

# FULL FUNCTION ELECTRIC OVEN

MAX. POWER: 2900W / 73L    2600W / 64L

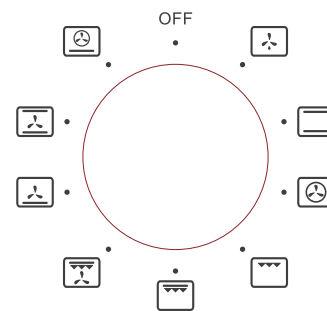
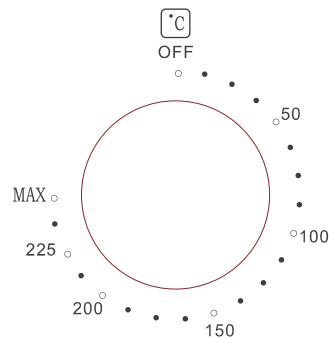

## RECOMMEND APPEARANCE



①



②



③



④



# FULL FUNCTION ELECTRIC OVEN

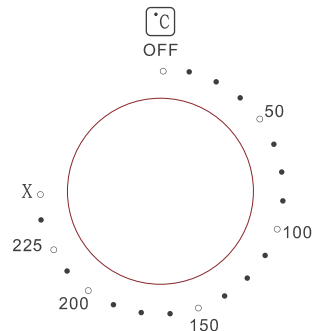
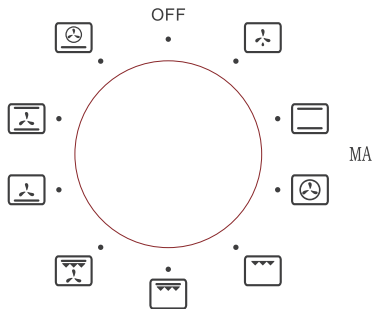
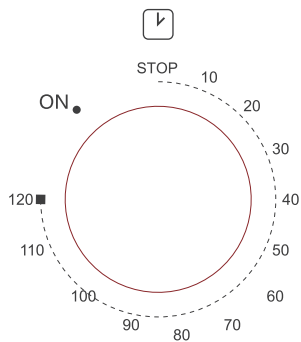

MAX. POWER: 2900W / 73L    2600W / 64L

## RECOMMEND APPEARANCE

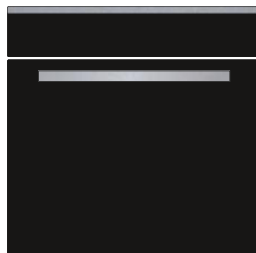

①

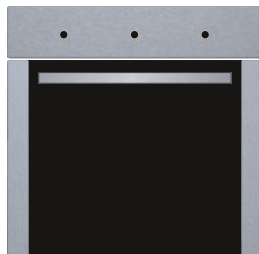

②

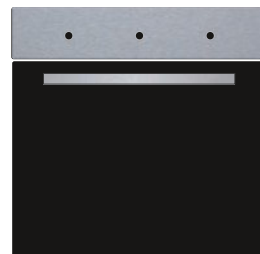

③



④



## HOT SELLING ELECTRIC OVEN

MAX. POWER: 2900W / 73L    2800W / 64L

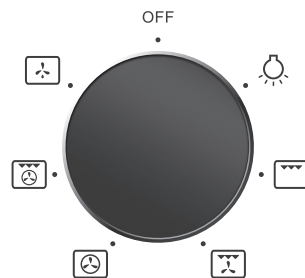
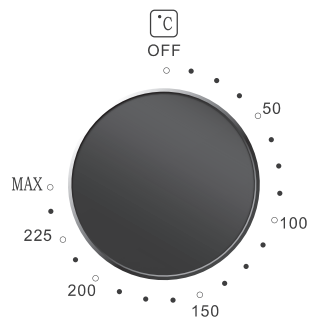



①

## RECOMMEND APPEARANCE



②

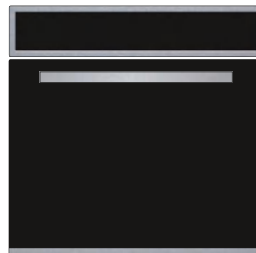

③



④

# HOT SELLING ELECTRIC OVEN

MAX. POWER: 2900W / 73L    2800W / 64L

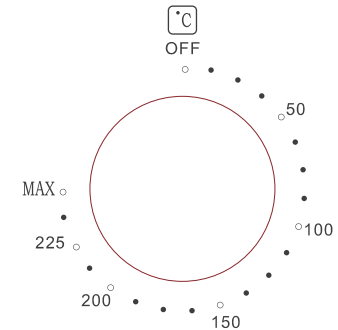
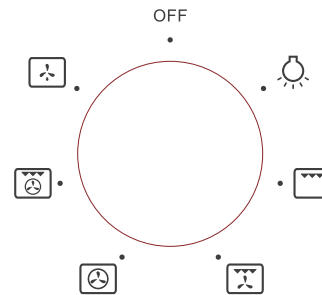
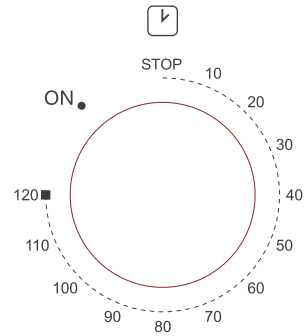

## RECOMMEND APPEARANCE



①



②



③



④





## **GAS OVEN**

---

# DIGITAL INTELLIGENT GAS OVEN

# DIGITAL INTELLIGENT GAS & ELECTRIC OVEN

Steam Clean	Conv Bake	Conv Roast	Conv Convert	Quick Preheat		1	2	3	Light	<b>Start</b> /Pause
	—	—	—	—		4	5	6	—	
Conv Fan ON/OFF	Broil	Bake	Defrost	Keep Warm		7	8	9	Timer ON/OFF	—
	—	—	—	—		Cook Time	0	Clock AM/PM	Delay Time	<b>Cancel</b> /OFF
Lock Hold 3 Sec	Air Fry	Proof	Probe	Rotisserie						

## RECOMMEND APPEARANCE

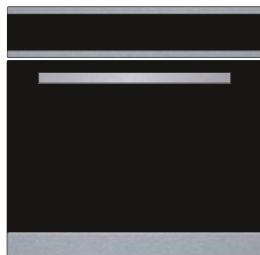

①



②



③

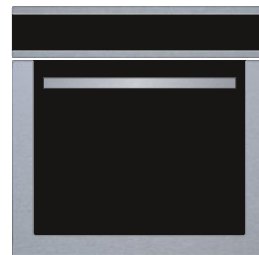

④



⑤



## FULL FUNCTION GAS OVEN

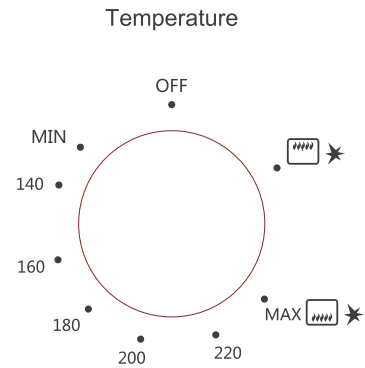
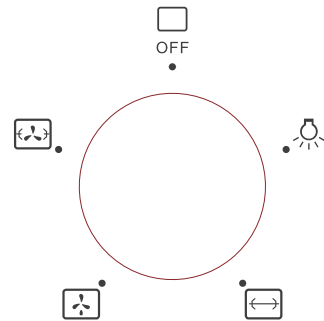

# RECOMMEND APPEARANCE

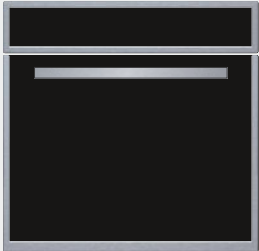

①

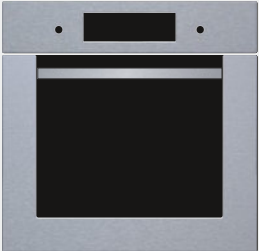

②

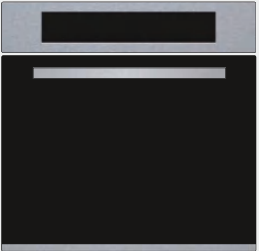

③

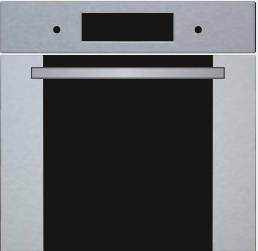

④



⑤



## FULL FUNCTION GAS OVEN

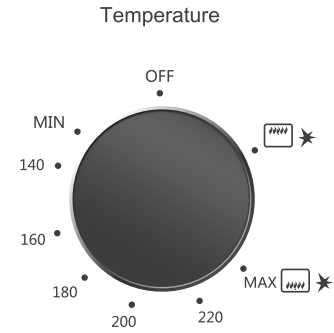
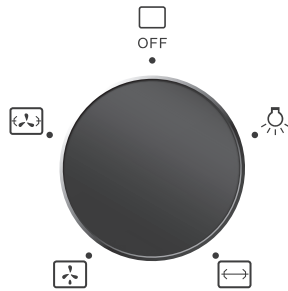
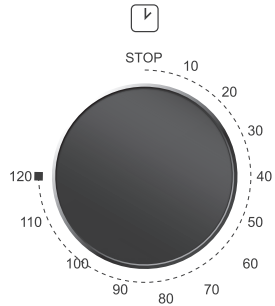

## RECOMMEND APPEARANCE



①



②



③



④



# FULL FUNCTION GAS & ELECTRIC OVEN

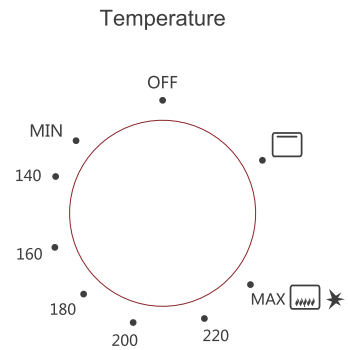
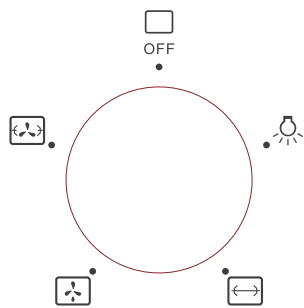

# RECOMMEND APPEARANCE



①

②

③



④



## FULL FUNCTION GAS & ELECTRIC OVEN

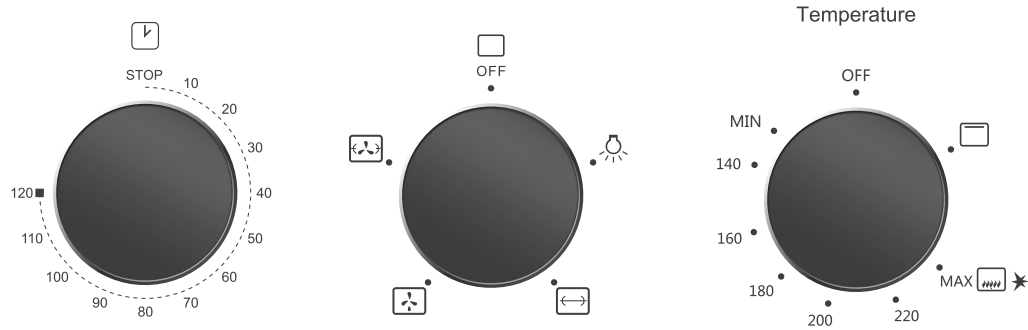

## RECOMMEND APPEARANCE



①

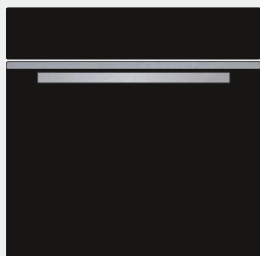

②

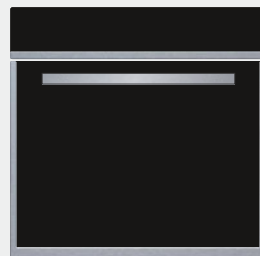

③



④

# ECONOMICAL GAS OVEN

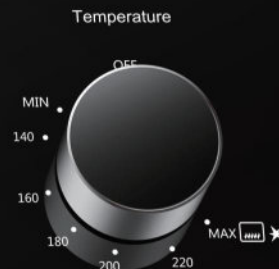
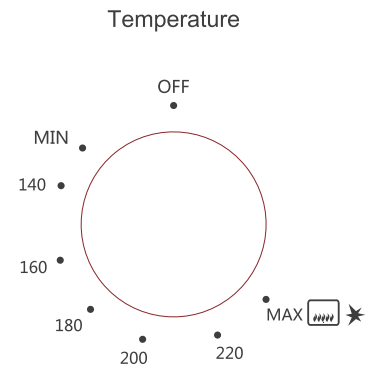
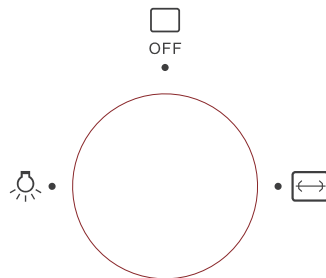
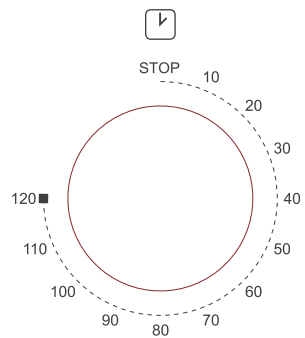

# ECONOMICAL GAS & ELECTRIC OVEN

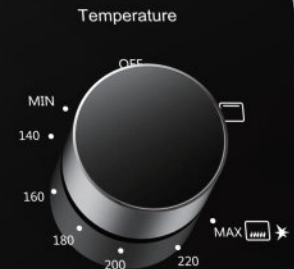
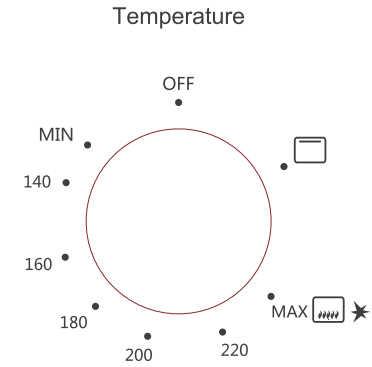
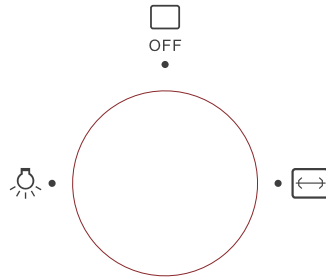
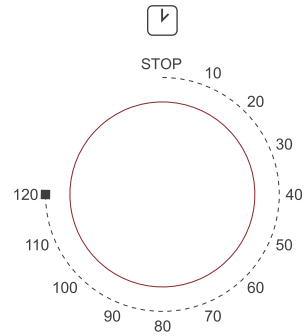



## RECOMMEND APPEARANCE

①

②

③

④





# RECOMMEND APPEARANCE



①



②

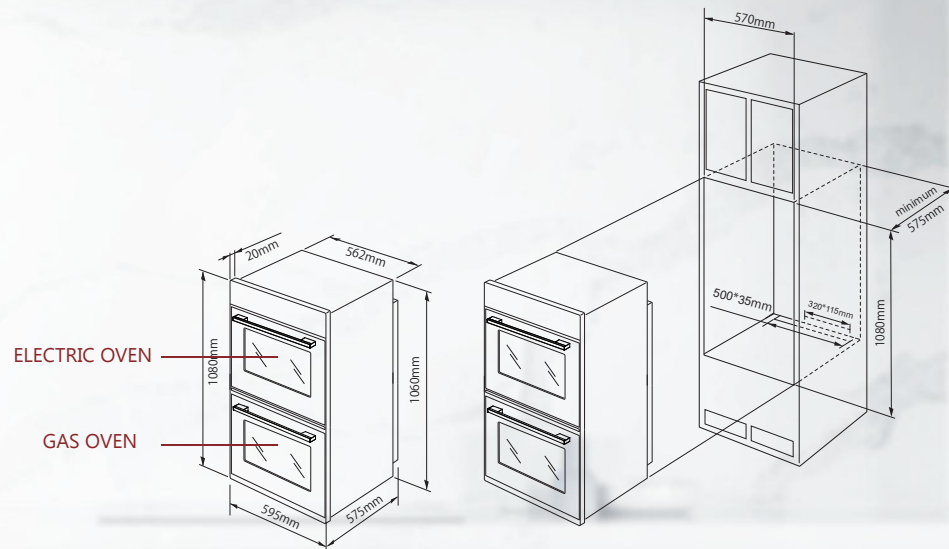

# SPECIAL SERIES



①



②



③



# SPECIAL SERIES



①

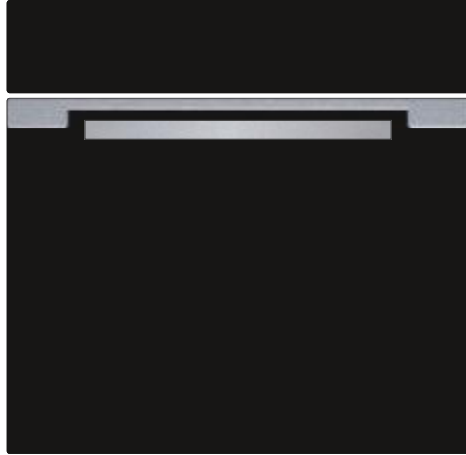

②



③

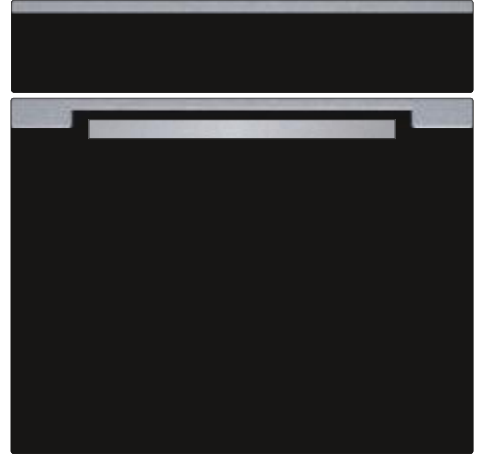

④



# SPECIAL SERIES



①

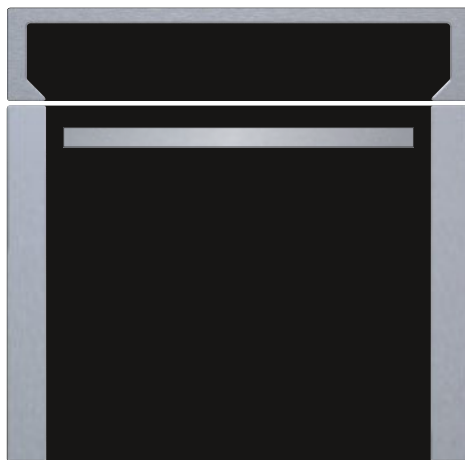

②

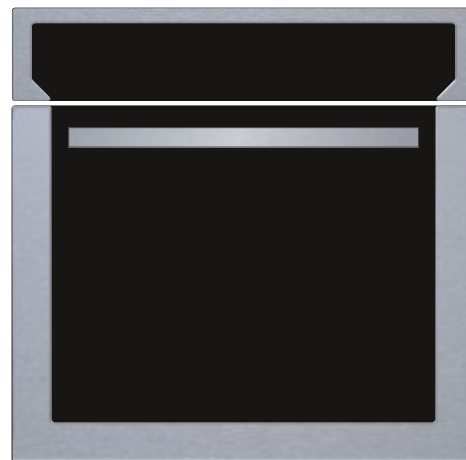

③



# SPECIAL SERIES



①



②



③

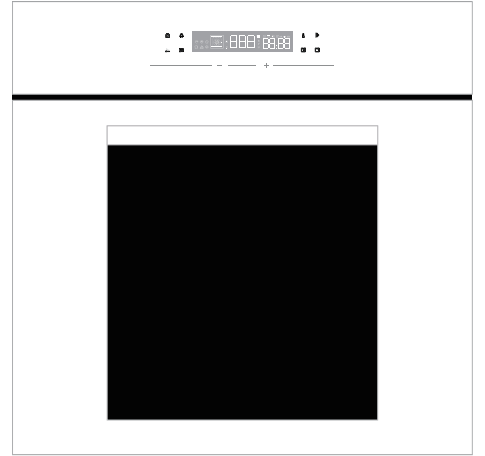

④







# GAS HOB BURNER SIZE

295\*510

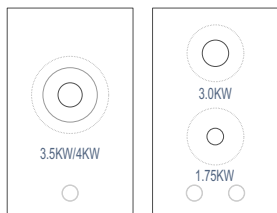

Cut-out Size:  
265X480

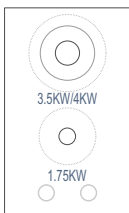

590\*510

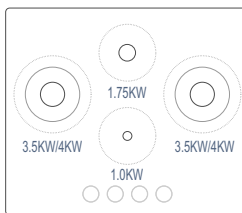
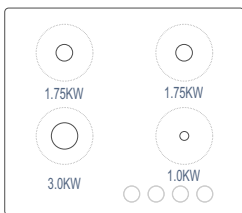
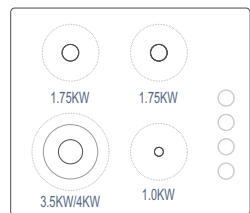
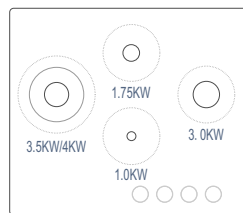
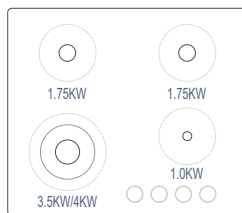
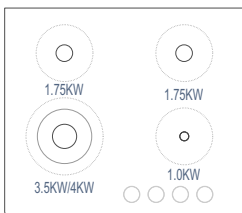
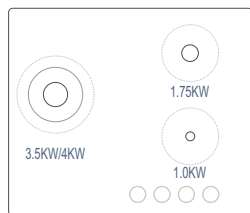

Cut-out Size:  
555X475XR20

760\*510

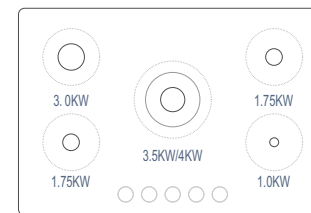
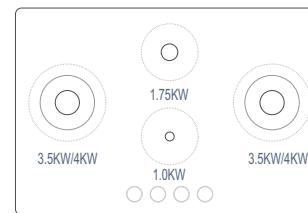
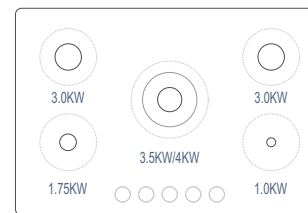

Cut-out Size:  
727X480

# GAS HOB BURNER SIZE

860\*510

915\*520

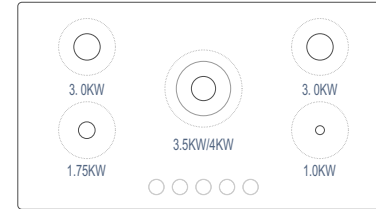
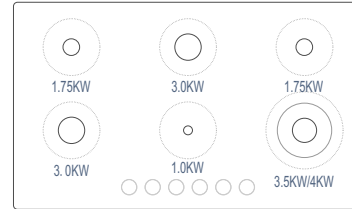
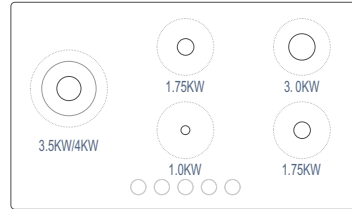
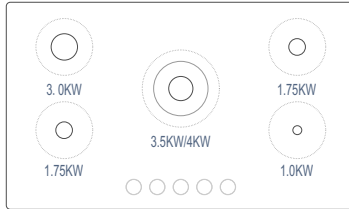

Cut-out Size:  
825X475XR20

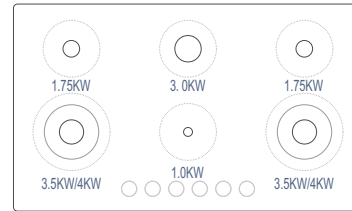
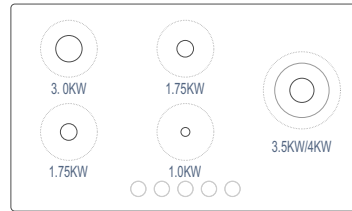

Cut-out Size:  
825X475

# GAS HOB SPECIAL FEATURES

## LED ILLUMINATED KNOBS

Red LED illuminated knob, shiny and practical, light up your kitchen  
The LED illuminated knob will light up when the burner is working, with functions of residual temperature indication, error and flameout indication.



## IRREVERSIBLE GRILL & GRIDDLE



## ROUND POT RACK

Cast iron round pot rack, can stable stable use of round pot

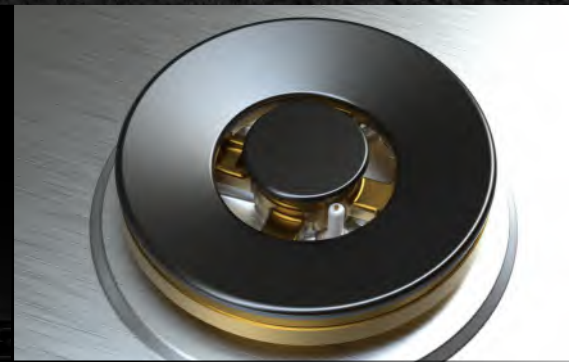

## BURNERS

Copper/Aluminum Burner, Power 3.5-5.0KW



## DIGITAL TOUCH TIMER

Digital touch timer control all burners



## MECHANICAL TIMER

Control triple ring burner individually



## MAIN SWITCH

Cut off the main gas supply and switch off all the burner at the same time.



## KITCHEN SCALE

# DIFFERENT PAN SUPPORT

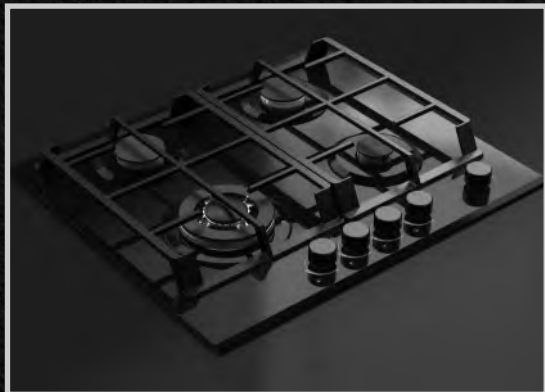

# CLASSICAL SERIES

295\*510

590\*510

760\*510

860\*510

A



B

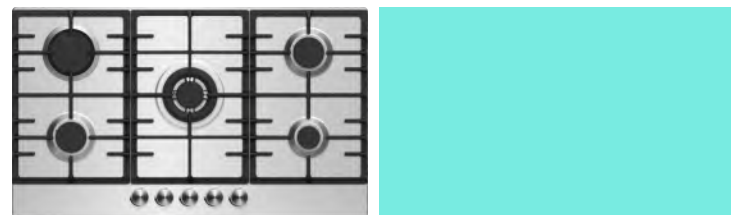
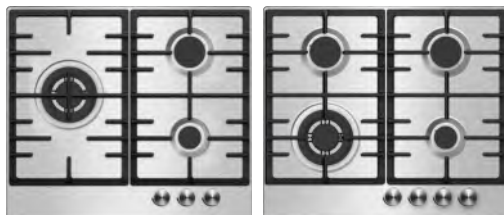
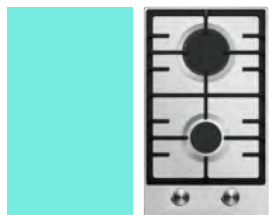

①

②

③

④

⑤

⑥

⑦

# HIGH POWER SERIES

590\*510

760\*510

860\*510

915\*520

A



B

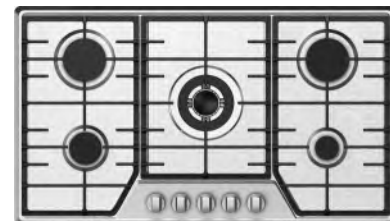
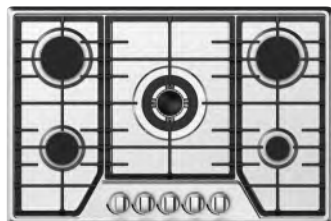

①

②

③

④

⑤

# WHEAT EAR SERIES

295\*510

590\*510

760\*510

860\*510

A



B

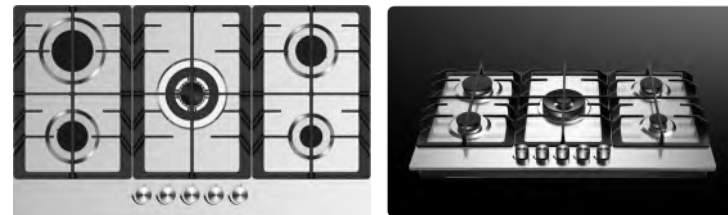
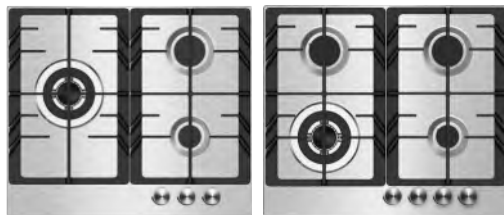
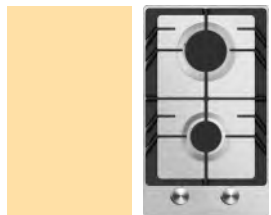

①

②

③

④

⑤

⑥

⑦

# STAR SERIES

590\*510

860\*510

A



B

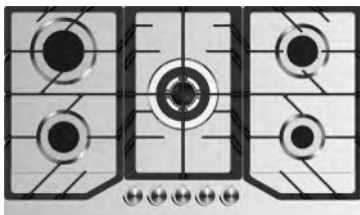

①

②

③

# FACET SERIES

295\*510

590\*510

860\*510

A



B

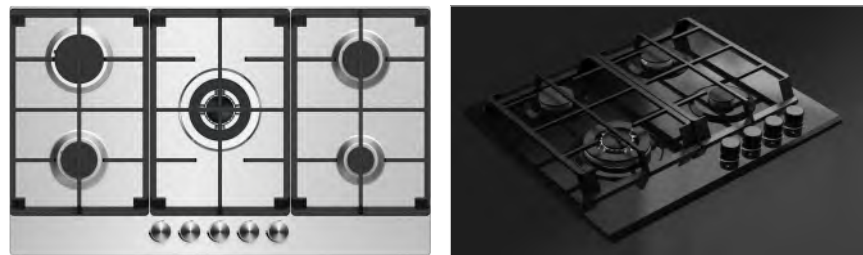
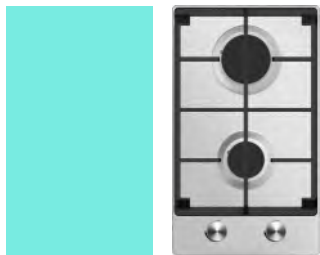

①

②

③

④

⑤

⑥

# BRIDGE SERIES

295\*510

590\*510

860\*510

A



B



①

②

③

④

# CHESS SERIES

295\*510

590\*510

760\*510

860\*510

A



B



①

②

③

④

⑤

⑥

# OCTOPUS SERIES

295\*510

590\*510

760\*510

860\*510

A



B



①

②

③

④

⑤

⑥

590\*510

A



B

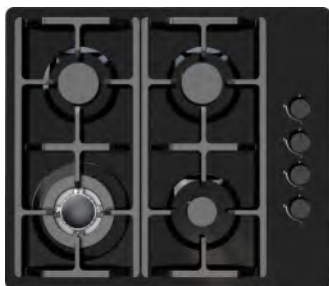

①

②

③



# FISHING NET SERIES

310\*510



①

②

760\*510



③

915\*520



④

# SPIDER SERIES

760\*510



①

915\*520



②

# BARBECUE SERIES

760\*510



①

915\*520



②



800\*450

760\*440

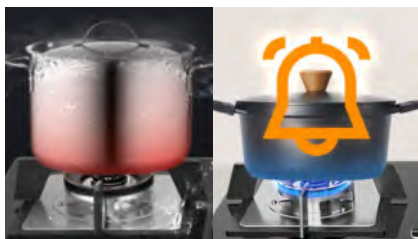

**--Dry burning protection**

The anti dry burn function will activate within 60 seconds when the temp. reach limit

**--Ultra sensitive temperature probe**

The gas will be cut off once the temp. exceed 280 °C

**--Smart reminder**

The beep reminder will be activated automatically to remind when it detect dry burning or non-connected of the dry burner probe.



**JZT-Q5L16F**

- Low battery reminder
- Anti dry burning technology
- Rating Power(kW): Left 4.5(NG) Right 5.2(NG)
- Anti scald reminder
- 5.2KW high power
- Thermal efficiency: 63%(NG)
- Cut-out Size(L\*W\*H): 630-680x330-370xR20\*4

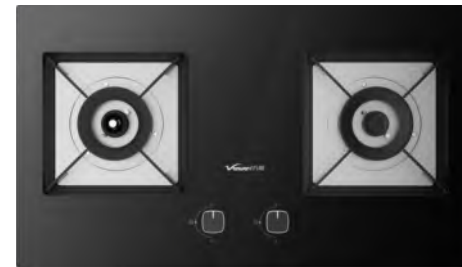

**JZT-P5L30**

- Anti dry burning technology
- Rating Power(kW): 5.0\*2(NG)
- 5.0KW high power
- Thermal efficiency: 65%(NG)
- Adjustable bottom shell size
- Cut-out Size(L\*W\*H): 630-680x330-370xR20\*4

**JZT/Y-C6L90**

- Anti scald reminder
- Rating Power(kW): 5.0\*2(NG/LPG)
- 5.0KW high power
- Thermal efficiency: 70%(NG),68%(LPG)
- Adjustable bottom shell size
- Cut-out Size(L\*W\*H): 630-680x330-370xR20\*4

**JZT/Y-B7L51**

- Rating Power(kW): 5.0\*2(NG)/4.5\*2(LPG)
- 5.0KW high power
- Thermal efficiency: 63%(NG/LPG)
- Adjustable bottom shell size
- Cut-out Size(L\*W\*H): 630-680x330-370xR20\*4

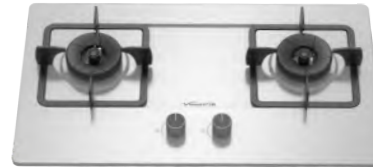
**JZT/Y-Q2G06**

- Rating Power(kW): 5.2\*2(NG)/4.8\*2(LPG)
- 5.2KW high power
- Thermal efficiency: 65%(NG),63%(LPG)
- Adjustable bottom shell size
- Cut-out Size(L\*W\*H): 630-680x330-370xR20\*4

**JZT/Y-Q2L06**

- Rating Power(kW): 5.2\*2(NG)/ 4.8\*2(LPG)
- 5.2KW high power
- Thermal efficiency: 65%(NG),63%(LPG)
- Adjustable bottom shell size
- Cut-out Size(L\*W\*H): 630-680x330-370xR20\*4

800\*450



**JZT-Q5L26**

**9-LEVEL PRECISE CONTROL**

- Anti scald reminder
- Rating Power(kW): 5.2\*2(NG/LPG)
- 5.2KW high power
- Thermal efficiency: 63%(NG/LPG)
- Cut-out Size(L\*W\*H): 680x370xR20\*4



**JZT-Q5L28Q3**

**9-LEVEL PRECISE CONTROL**

**DIGITAL TIMER**

- Anti scald reminder
- Rating Power(kW): 5.2\*2(NG/LPG).
- 5.2KW high power
- Thermal efficiency: 70%(NG/LPG)
- Adjustable bottom shell size
- Cut-out Size(L\*W\*H): 650-710x350-400xR20\*4

# ELECTRIC COOKER COLLECTION



# CERAMIC HOB

770\*520  
HQ5W831A

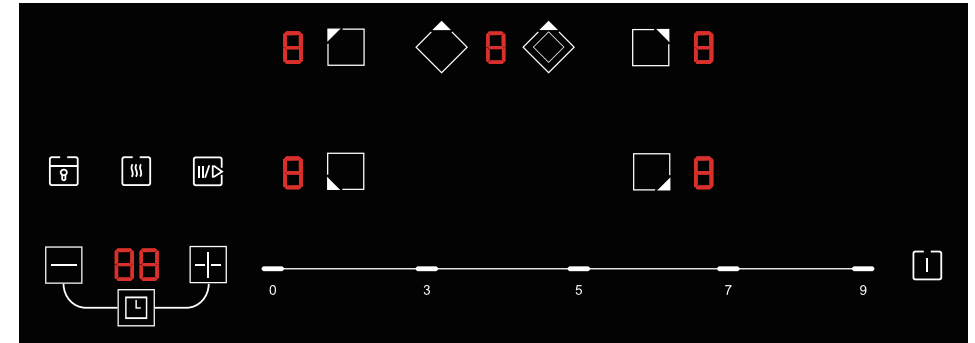
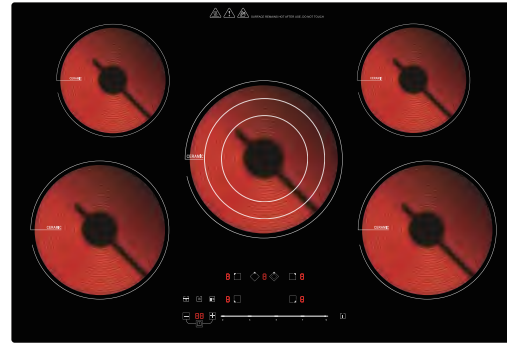
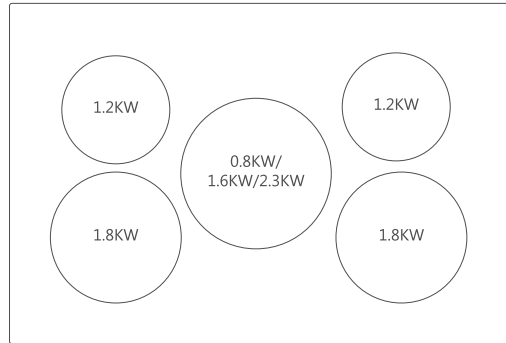

Product Size ( mm ): 770\*520\*50  
Package ( W x H x D, mm ): 840\*105\*585  
Installation ( mm ): 750\*490  
Loading ( 20'/40'/40HQ ): 335/704/792

Control Type: Slider touch control  
Heater Style: Triple rings  
Warm & Pause: Warm & Pause  
Power Rating ( W ): 8300

# CERAMIC HOB

590\*520  
HQ4W661Q

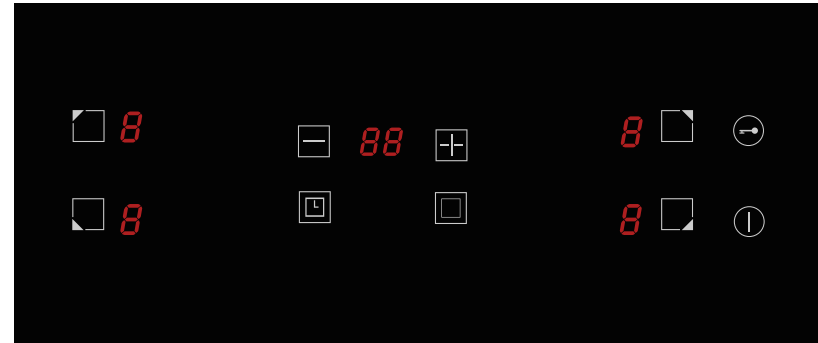
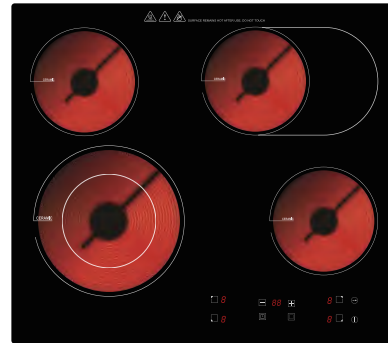
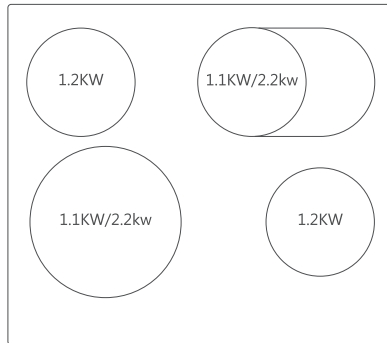

Product Size ( mm ):	590*520*50
Package ( W x H x D, mm ):	560*105*640
Installation ( mm ):	560*490
Loading ( 20'/40'/40HQ ):	820/1650/1900

Control Type	Touch control
Heater Style	Oval dual-ring
Warm & Pause	Warm
Power Rating ( W )	6600

# CERAMIC HOB

590\*520  
HQ3W521K

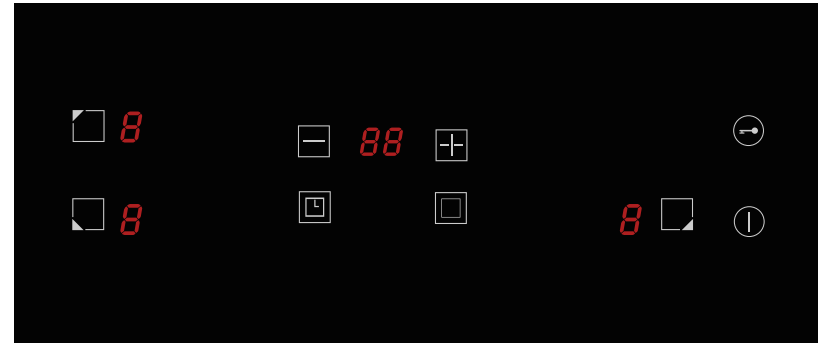
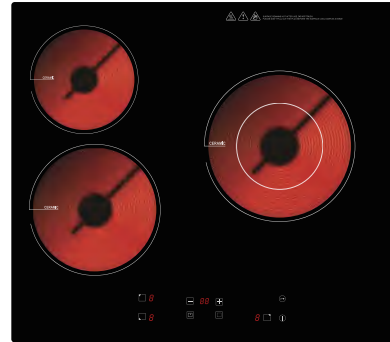
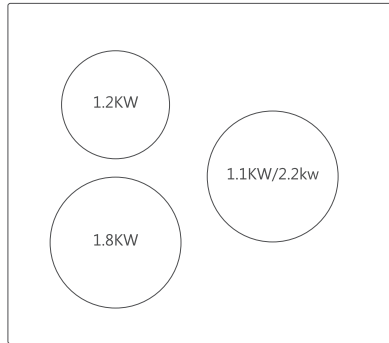

Product Size ( mm ):	590*520*50
Package ( W x H x D, mm ):	560*105*640
Installation ( mm ):	560*490
Loading ( 20'/40'/40HQ ):	820/1650/1900

Control Type	Touch control
Heater Style	Dual ring
Warm & Pause	/
Power Rating ( W )	5200

# CERAMIC HOB

590\*520

HQ4W601S0

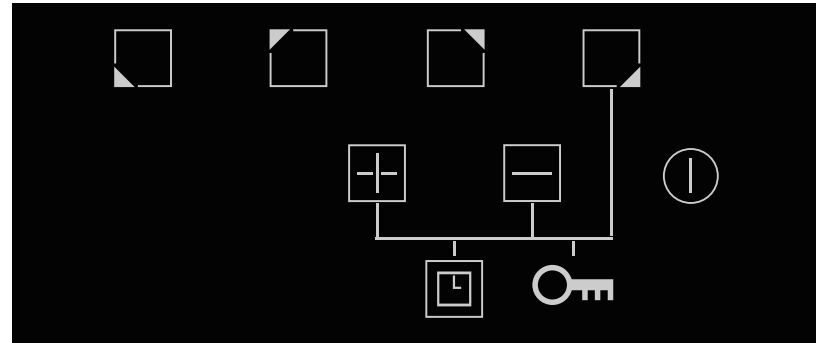
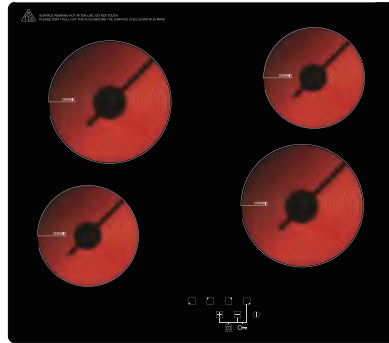
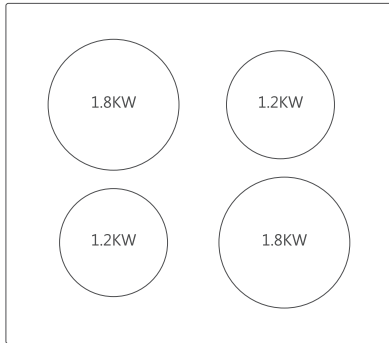

Product Size ( mm ):

590\*520\*50

Package ( W x H x D, mm ):

653\*110\*683

Installation ( mm ):

560\*490

Loading ( 20'/40'/40HQ ):

588/1218/1414

Control Type

Touch control

Heater Style

Single ring

Warm & Pause

/

Power Rating ( W )

6000

# CERAMIC HOB

450\*510  
HQ3W421A0

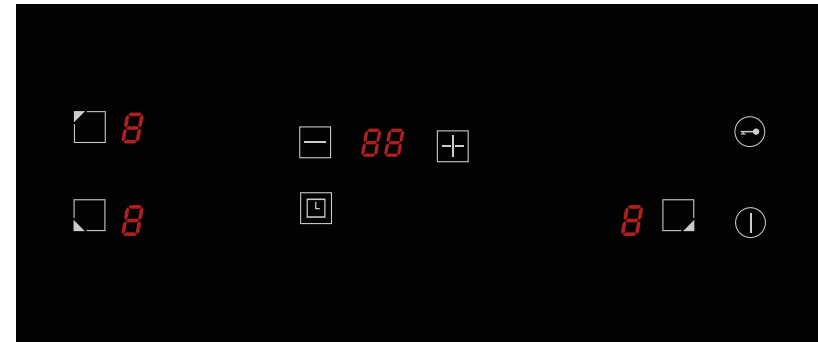
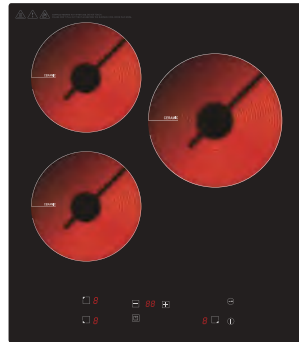
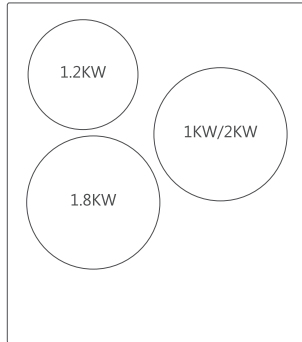

Product Size ( mm ):	450*510*50
Package ( W x H x D, mm ):	520*105*580
Installation ( mm ):	430*490
Loading ( 20'/40'/40HQ ):	880/1820/2130

Control Type	Touch control
Heater Style	Dual ring
Warm & Pause	/
Power Rating ( W )	5000

# CERAMIC HOB

290\*520  
HQ2W301L0

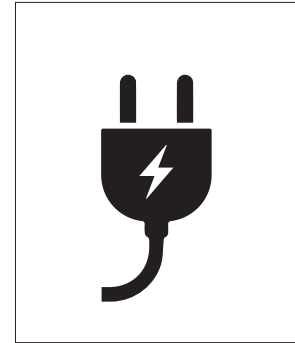
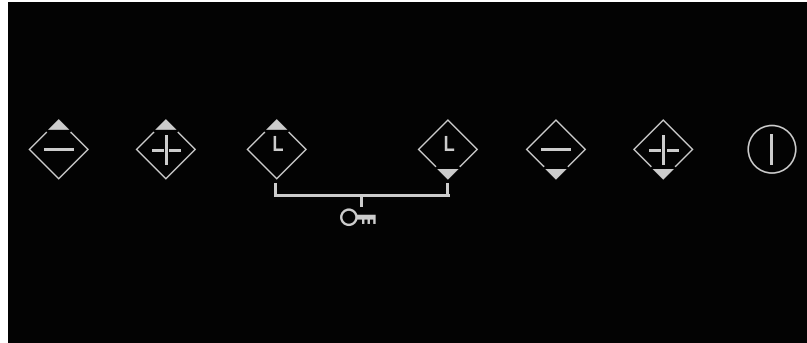
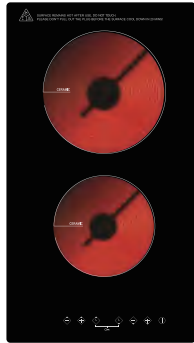
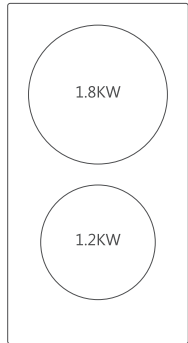

Product Size ( mm ): 290\*520\*50  
Package ( W x H x D, mm ): 370\*110\*585  
Installation ( mm ): 260\*490  
Loading ( 20'/40'/40HQ ): 1186/2480/2829

Control Type Touch control  
Heater Style Dual ring  
Warm & Pause /  
Power Rating ( W ) 3000

Electric plug

# INDUCTION HOB

590\*520

HQ4C721G2

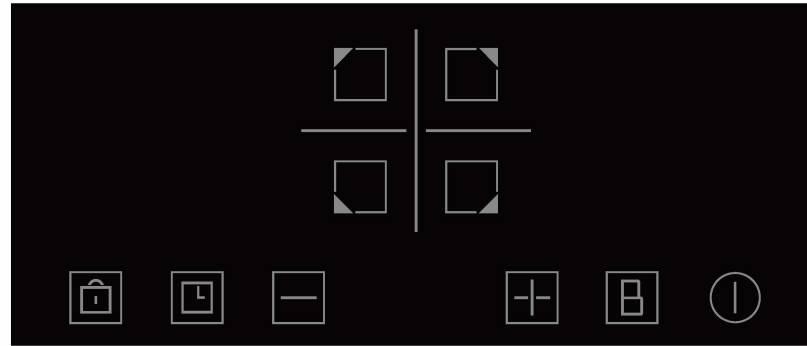
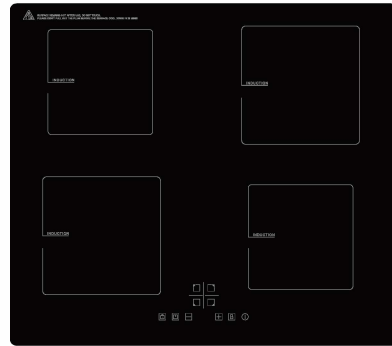
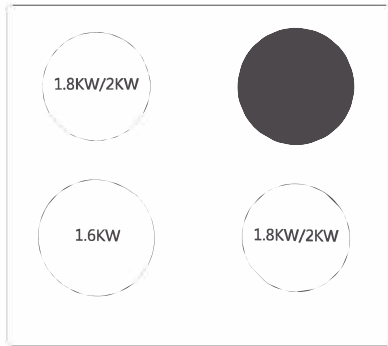

Product Size ( mm ):

590\*520\*57

Package ( W x H x D, mm ):

560\*105\*640

Installation ( mm ):

560\*480  
820/1650/1900

Control Type

Touch control

Warm & Pause

/

Power Rating ( W )

7200

Bevelled edges



White



Off White

# INDUCTION HOB

590\*520

HQ4C722A0

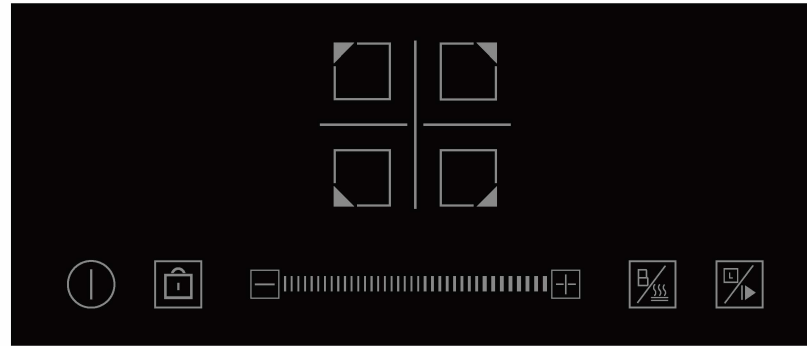
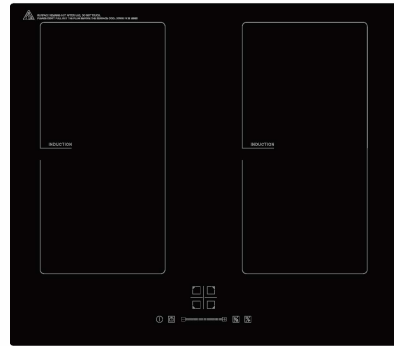

Product Size ( mm ):	590*520*60
Package ( W x H x D, mm ):	635*110*683
Installation ( mm ):	565*495
Loading ( 20'/40'/40HQ ):	588/1218/1414

Control Type	Slider touch control
Warm & Pause	Warm & Pause
Power Rating ( W )	7200

Bevelled edges

 White  Off White

# INDUCTION HOB

590\*520

HQ3C651B1

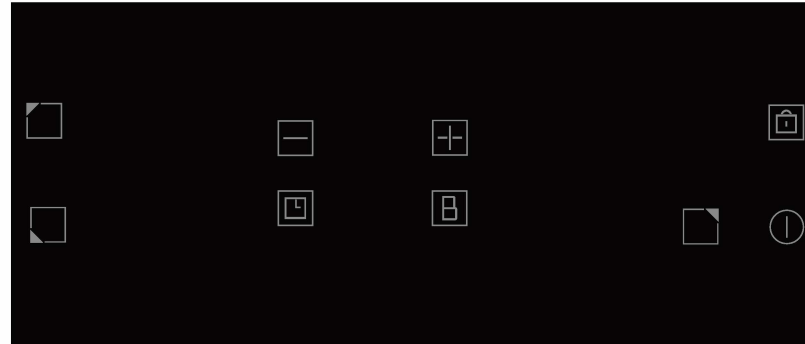
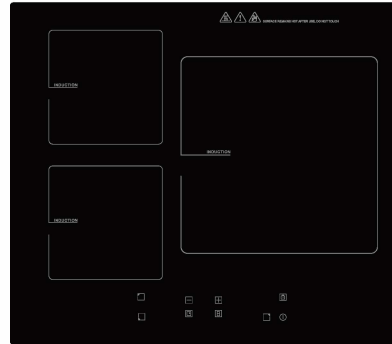
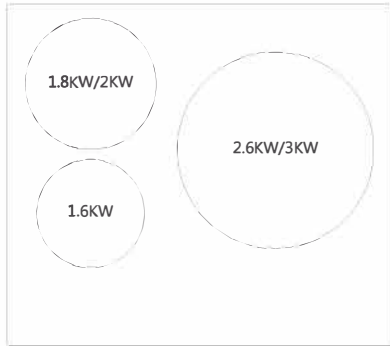

Product Size ( mm ):

590\*520\*57

Package ( W x H x D, mm ):

560\*105\*640

Installation ( mm ):

560\*480

Loading ( 20'/40'/40HQ ):

820/1650/1900

Control Type

Touch control

Warm & Pause

Warm & Pause

Power Rating ( W )

6500

Bevelled edges



White



Off White

# INDUCTION HOB

590\*520  
HQ4C721A4

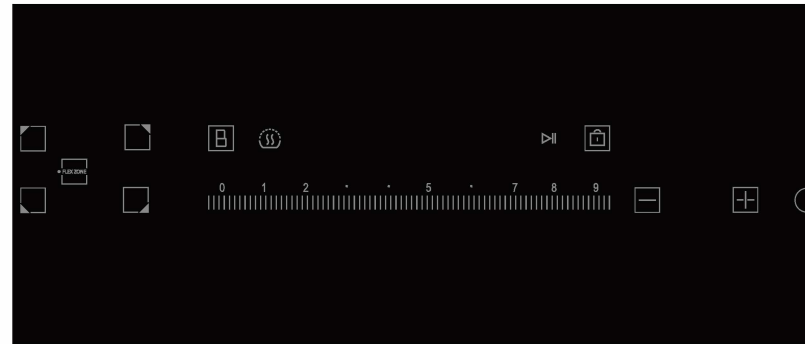
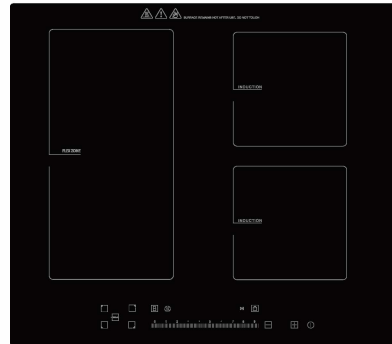
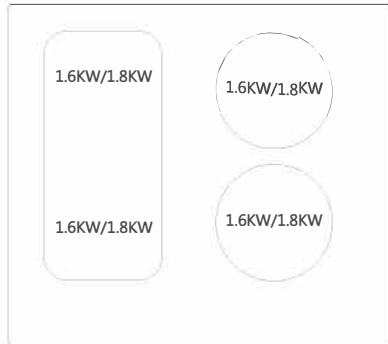

Product Size ( mm ):	590*520*57
Package ( W x H x D, mm ):	560*105*640
Installation ( mm ):	560*480
Loading ( 20'/40'/40HQ ):	820/1650/1900

Control Type	Slider touch control
Warm & Pause	Warm & Pause
Power Rating ( W )	7200

Bevelled edges

 White  Off White

# INDUCTION HOB

290\*520  
HQ2C351A0

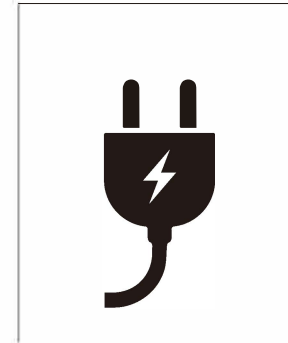
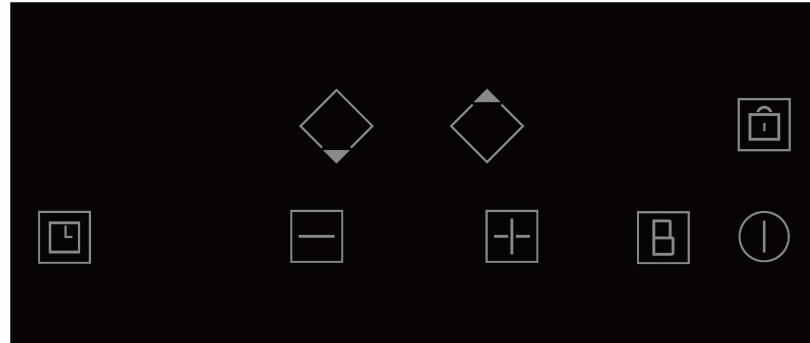
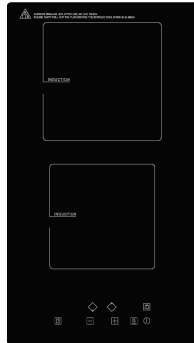

Product Size ( mm ): 290\*520\*64  
Package ( W x H x D, mm ): 370\*120\*585  
Installation ( mm ): 265\*495  
Loading ( 20'/40'/40HQ ): 1068/2232/2640

Control Type	Touch control
Warm & Pause	/
Power Rating ( W )	3500

Electric plug

White  
Off White

# INDUCTION HOB

290\*520  
HQ2C352A1

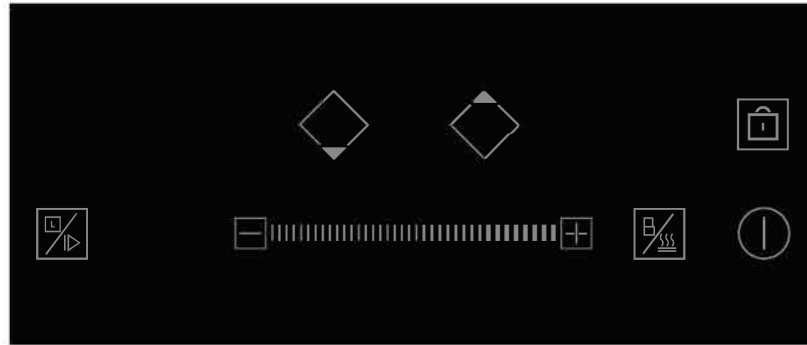
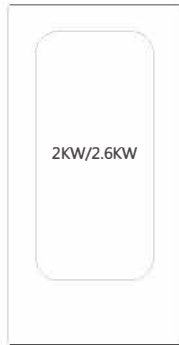

Product Size ( mm ):	290*520*64
Package ( W x H x D, mm ):	370*120*585
Installation ( mm ):	265*495
Loading ( 20'/40'/40HQ ):	1068/2232/2604

Control Type	Slider touch control
Warm & Pause	Warm & Pause
Power Rating ( W )	3500

 White  
 Off White

# RANGE HOODS COLLECTION



# RANGE HOODS

L07SE



Overall dimension (mm) : 895\*350\*1040  
Air extraction volume/stir-fry mode (m3/min) : 18/22  
Noise Level: 70dB (A) , 56dB

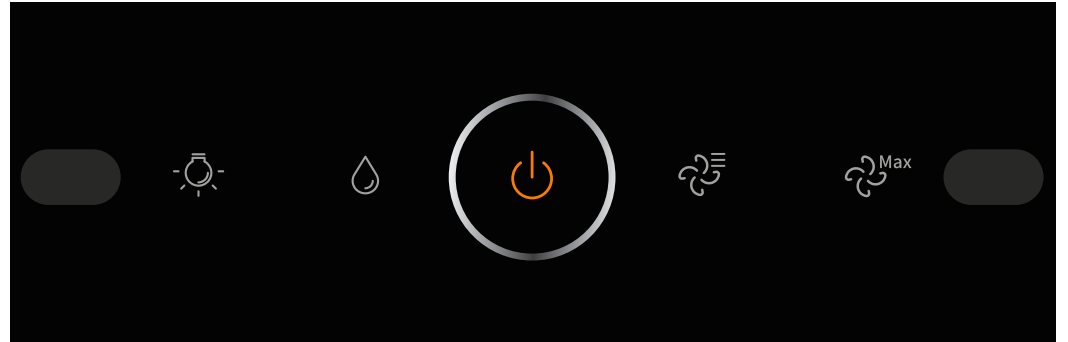

Self-cleaning function  
Fume Capture Shield could be opened at the angle which is easy to clean  
Motion Activation

# RANGE HOODS

L12SE



Overall dimension (mm) : 895\*340\*908  
Air extraction volume/stir-fry mode (m3/min) : 20/23  
Noise Level: 69dB (A) , 55dB

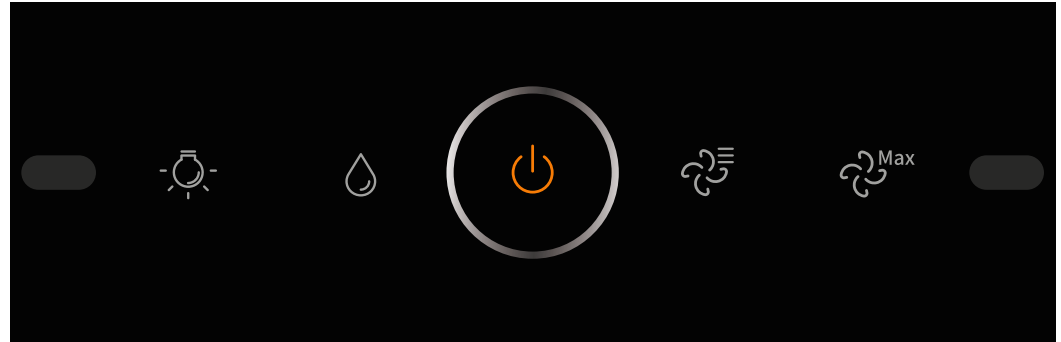

500Pa Auto Turbo Mode, automatically adjusting fan speed for optimal extraction.  
N-touch hover gesture operation, start to work in a second.  
Intelligent high temperature cleaning,  
Delayed oil purification, persistently powerful smoke extraction.

# RANGE HOODS

J26SE



Overall dimension (mm) :

895\*375\*745

Air extraction volume/stir-fry mode (m3/min) :

19/22

Noise Level:

69dB (A) , 55dB

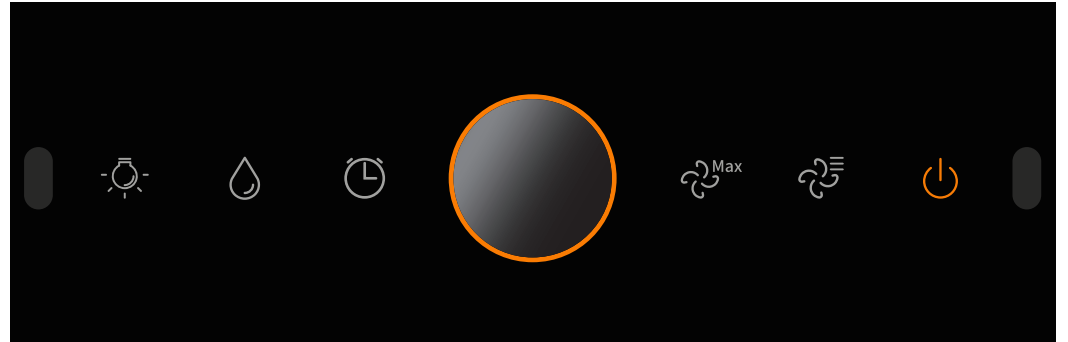

Intelligent Open/Close fume capture shield

N-touch motion activate to work,intelligent high temperature cleaning.

Delayed oil purification, persistently powerful smoke extraction.

# RANGE HOODS

X739A



Overall dimension (mm) :	896*450*680
Air extraction volume/stir-fry mode (m3/min) :	18/22
Noise Level:	70dB (A) , 56dB

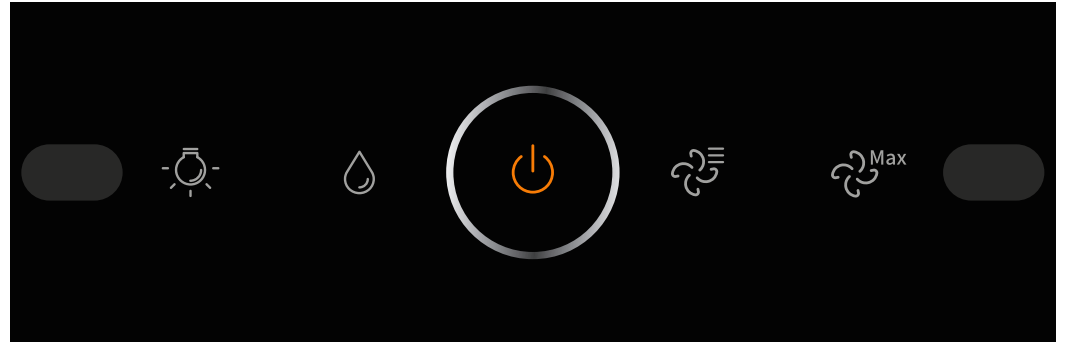

Intelligent high temperature cleaning,  
Delayed oil purification, persistently powerful smoke extraction.  
Smoke collecting center plate, deep cavity smoke collecting, never let smoke escape.  
N-touch motion activate to work.

# RANGE HOODS

DJ738



Overall dimension (mm) : 895\*435\*495  
Air extraction volume/stir-fry mode (m3/min) : 18/22  
Noise Level: 70dB (A) , 56dB

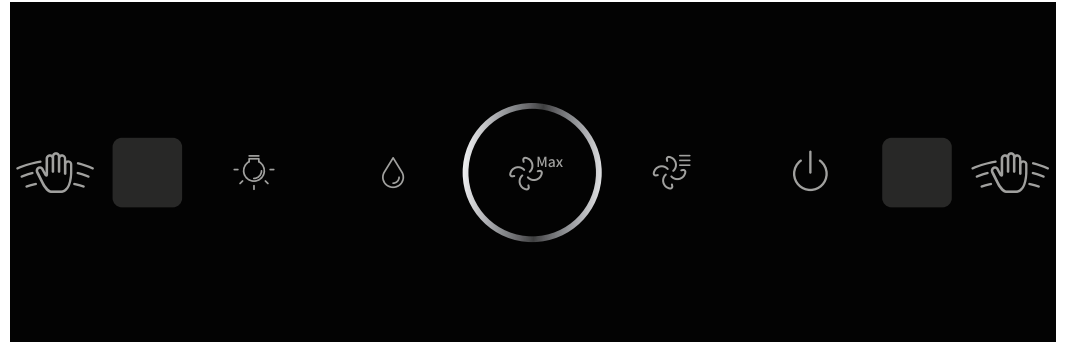

N-touch hover gesture operation, start to work in a second.  
Intelligent high temperature cleaning,  
Delayed oil purification, persistently powerful smoke extraction.

# RANGE HOODS

J05SE(S)



Overall dimension (mm) :	896*407*464
Air extraction volume/stir-fry mode (m3/min) :	17
Noise Level:	70dB (A) , 56dB

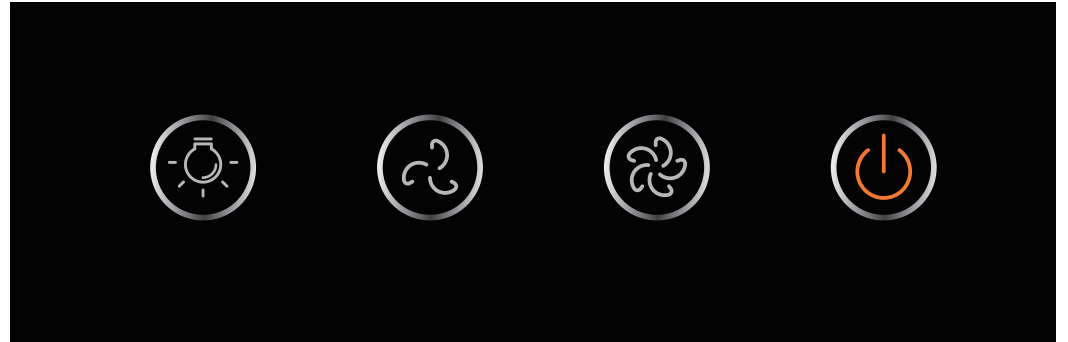

Second generation dual turbo technology,  
17 cubic meters of large suction  
4D stereoscopic smoking port, preventing oil fumes from escaping

# RANGE HOODS

6660C



Overall dimension (mm) : 500/600\*500\*460-840  
Air extraction volume/stir-fry mode (m3/min) : 8/11  
Noise Level:

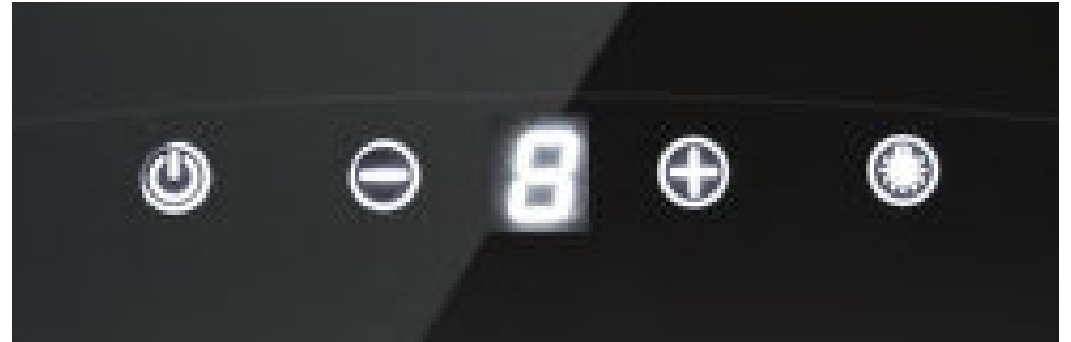

stainless steel & toughened glass  
3 speed touch contro  
Auto clean optional  
Switch option: push button controll

# RANGE HOODS



Overall dimension (mm) : 500/600\*500\*460-840  
Air extraction volume/stir-fry mode (m3/min) : 8/11  
Noise Level:

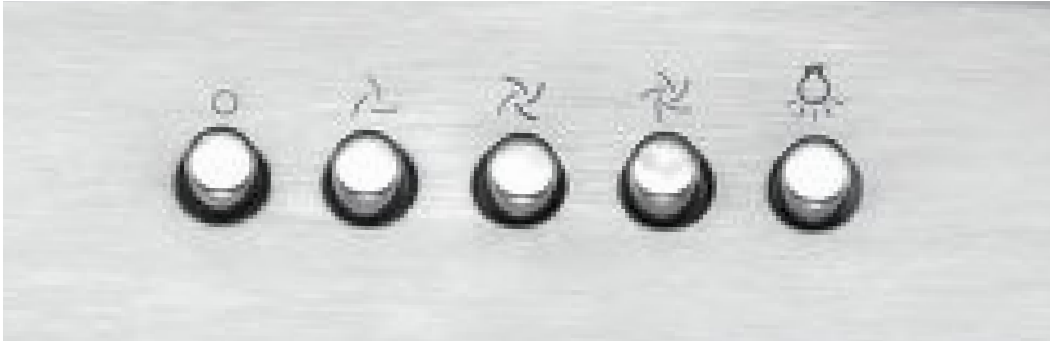

stainless steel & toughened glass  
3 speed push button control  
Switch option: touch control